



Electrolux
PROFESSIONAL

Ventilation Equipment
430 S/S Wall Hood+Filter+Fan
1600x1100mm

ITEM # _____

MODEL # _____

NAME # _____

SIS # _____

AIA # _____



644221 (ABPV1116BT)

430 stainless steel Wall Hood with filters and exhauster

Short Form Specification

Item No. _____

Constructed in 430 AISI stainless steel. Equipped with labyrinth filters in 430 AISI stainless steel, blind panels in 304 AISI stainless steel, grease collecting trough all around and condensate collecting tray.

Centrifugal fan, with enclosed type motor, mounted inside the filter battery.

Main Features

- External panels with upturned edges to avoid injuries.
- Prearranged for installation of lighting.
- Low noise level.

Construction

- Eyebolts and screw anchors for ceiling installation.
- Outlet holes are sized in order to minimize drops in pressure.
- 304 AISI stainless steel condensation collection tray.
- Labyrinth filters guarantee constant filtration to avoid clogging and to protect against fire.
- 304 AISI stainless steel blind panels for a correct exhaustion.
- 430 AISI stainless steel labyrinth filters easily removable for cleaning.
- Perimetral gutter with drain hole to transfer grease into a 304 AISI container.
- Entirely constructed in 430 AISI stainless steel.
- Lead hole for electric cable on top.

APPROVAL: _____



Experience the Excellence
www.electroluxprofessional.com

Front

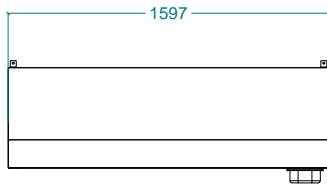

Side

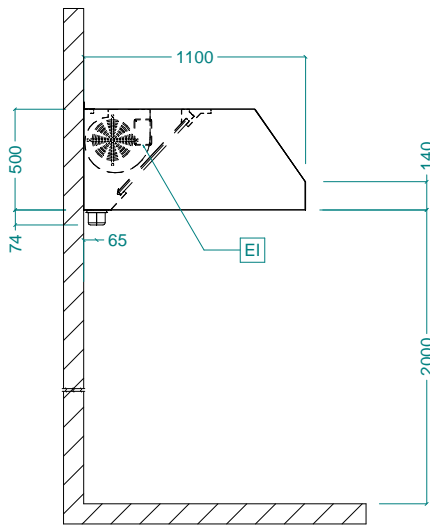

EI = Electrical inlet (power)

Top

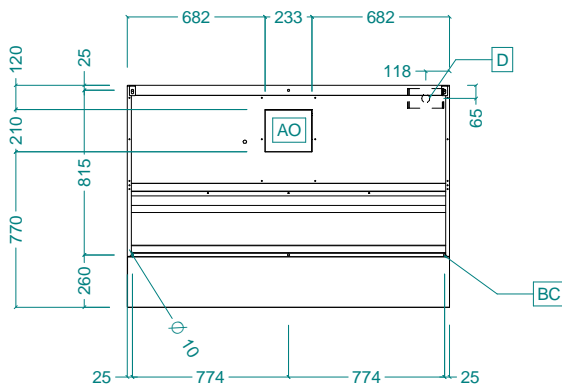

Electric

Supply voltage:

644221 (ABPV1116BT) 220-240 V/1N ph/50 Hz

Total Watts:

0.3 kW

Built-in Fan Power:

300 W

Key Information:

External dimensions, Width: 1600 mm

External dimensions, Depth: 1100 mm

External dimensions, Height: 500 mm

Net weight: 52 kg

Air Emission:

Air capacity: 1900 mc/h